

## 3/2-Wege Coaxialventil 3/2-way coaxial valve

## Baureihe 380 / 381 Type 380 / 381

**fremdgesteuert**  
**externally controlled**

Schaltfunktion A: NC (stromlos geschlossen)  
function A: NC (normally closed)

Schaltfunktion B: NO (stromlos offen)  
function B: NO (normally open)

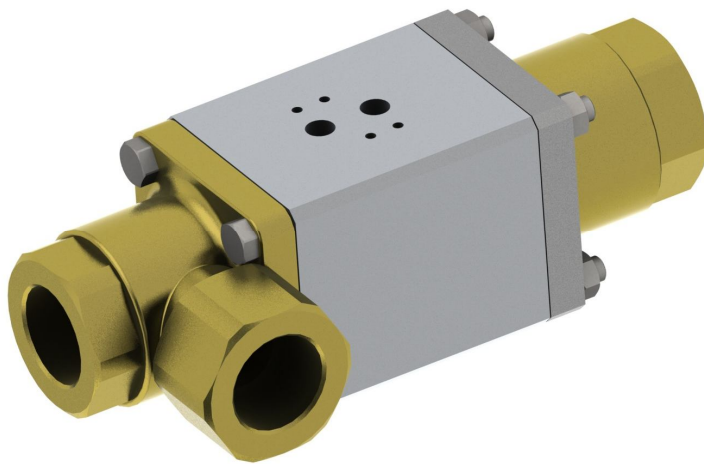
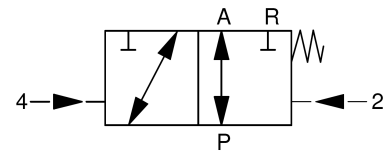
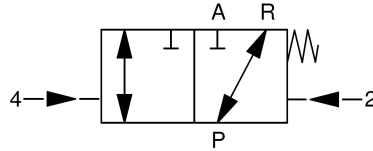

<b>Nennweite</b>	DN 10 – 50	<b>diameter</b>	DN 10 – 50
<b>Druckbereich</b>	0 – max. 100bar gedrückt bis max. 16bar	<b>pressure range</b>	0 – max. 100bar backpressure leakproof up to max. 16bar
<b>Gehäusewerkstoff</b>	Muffenausführung: Messing, 1.4305, 1.4571	<b>body material</b>	threaded version: brass, AISI 303, AISI 316
<b>Dichtwerkstoff</b>	statisch: FKM dynamisch: FKM, PTFE Sitzdichtung: PTFE	<b>seal material</b>	static: FKM dynamic: FKM, PTFE seat seal: PTFE
<b>Temperatur</b>	Medium: -10 bis +100°C Umgebung: -10 bis +50°C	<b>temperature</b>	media: -10 up to +100°C ambient: -10 up to +50°C
<b>Anschluss</b>	G1/4 – G2	<b>connection</b>	G1/4 – G2
<b>Durchflussrichtung</b>	P → A max. 100bar A → P max. 16bar P → R max. 100bar R → P max. 16bar	<b>flow direction</b>	P → A max. 100bar A → P max. 16bar P → R max. 100bar R → P max. 16bar
<b>Antriebsteil</b>	doppelt wirkender Kolben mit Rückstellfeder	<b>actuating part</b>	double acting piston with return spring
<b>Steuerdruck</b>	3 – 8bar Anschlüsse 2+4 (G1/4) Schnittstelle nach NAMUR  eine vorgeschaltete Wartungseinheit verlängert die Lebensdauer der Ventile	<b>control pressure</b>	3 – 8bar connections 2+4 (G1/4) port according to NAMUR  an upstreamed service unit extends the lifetime of the valves
<b>Schaltzeiten</b>	Öffnen / Schließen 50 – 1000ms abhängig vom Steuerdruck, Pilotventil (Option) und Abluftdrosseln (Option)	<b>switching time</b>	opening / closing 50 – 1000ms depending on operating pressure, pilot valve (option) and exhaust air throttle (option)
<b>Einbaulage</b>	beliebig	<b>mounting</b>	in any position

**3/2-Wege Coaxialventil**  
*3/2-way coaxial valve*
**Baureihe 380 / 381**  
**Type 380 / 381**

Baureihe type	DN [mm]	Druck pressure range [bar]	Anschluss connection	K <sub>v</sub> -Wert flow rate [m <sup>3</sup> /h]	Gewicht – Messing weight - brass [kg]
380	10	0 – 64	G1/4, G3/8, G1/2	2,5	1,8
380	15	0 – 64	G3/8, G1/2, G3/4	6,6	3,2
380	20	0 – 64	G1/2, G3/4, G1	10,0	4,6
380	25	0 – 64	G3/4, G1, G1 1/4	12,2	6,5
380	32	0 – 64	G1, G1 1/4, G1 1/2	17,9	7,6
380	40	0 – 64	G1 1/2	41,5	12,1
380	50	0 – 64	G2	43,0	12,1
381	10	0 – 100	G1/4, G3/8, G1/2	2,5	1,8
381	15	0 – 100	G3/8, G1/2, G3/4	6,6	3,2
381	20	0 – 100	G1/2, G3/4, G1	10,0	4,6
381	25	0 – 100	G3/4, G1, G1 1/4	12,2	6,5
381	32	0 – 100	G1, G1 1/4, G1 1/2	17,9	7,6
381	40	0 – 100	G1 1/2	41,5	12,1
381	50	0 – 100	G2	43,0	12,1

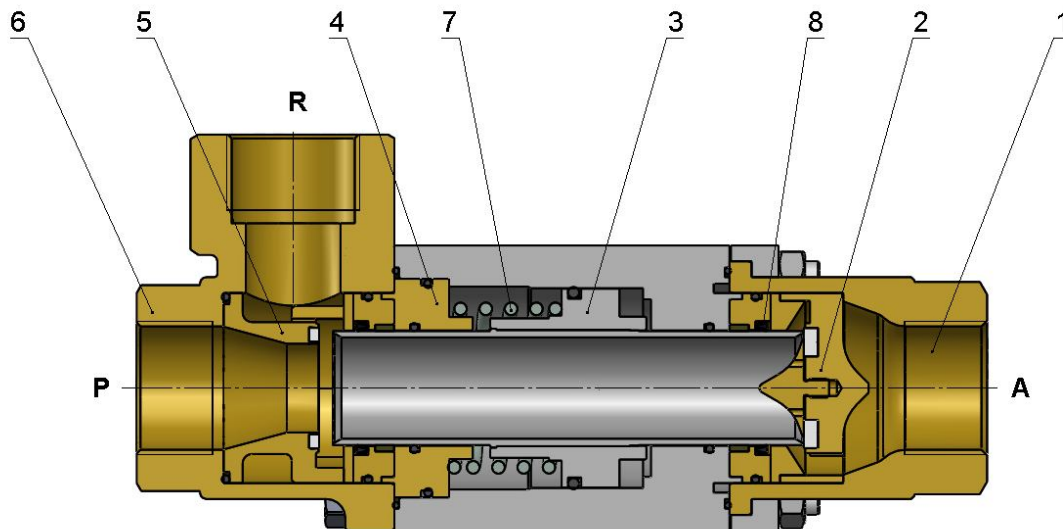
**Schnittzeichnung**  
*sectional drawing*

Pos. pos.	Menge quantity	Benennung	description
1	1	2/2-Wege Anschlussstück	2/2-way adapter fitting
2	1	2/2-Wege Ventilsitz	2/2-way valve seat
3	1	Kolben / Steuerrohr	piston / control tube
4	1	Betätigungsscheibe	actuating plate
5	1	3/2-Wege Ventilsitz	3/2-way valve seat
6	1	3/2-Wege Anschlussstück	3/2-way adapter fitting
7	1	Feder	spring
8	2	PTFE-Stangendichtung	PTFE-rod seal

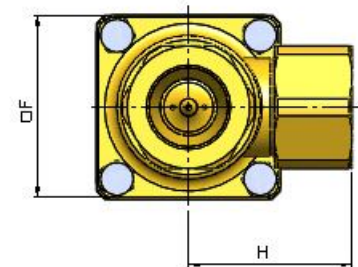
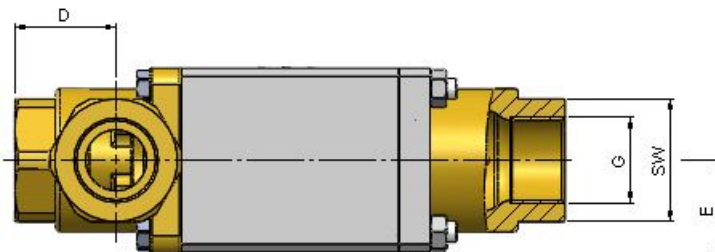
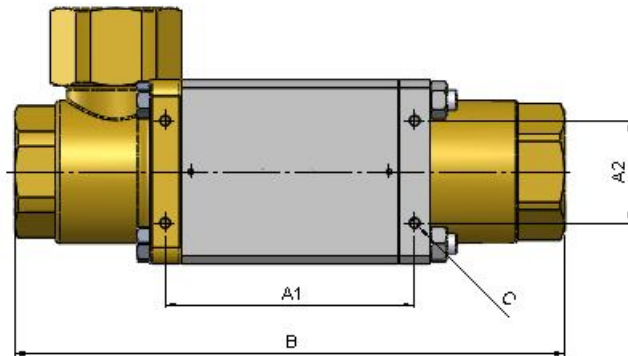
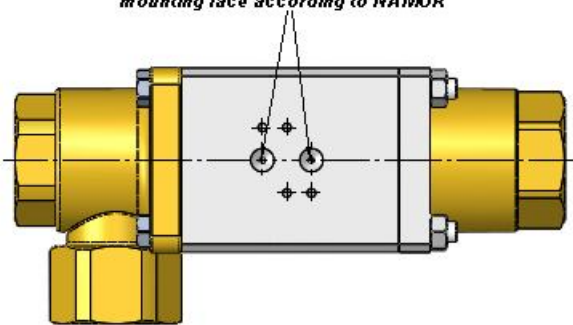
**3/2-Wege Coaxialventil**  
*3/2-way coaxial valve*
**Baureihe 380 / 381**  
**Type 380 / 381**
**Maßzeichnung**  
*dimension drawing*

**Steueranschluss G1/4**  
*control port G1/4*
**Anschlussbild nach NAMUR**  
*mounting face according to NAMUR*

DN [mm]	G	SW	A1 [mm]	A2 [mm]	B [mm]	C [mm]	D [mm]	E [mm]	F [mm]	H [mm]
10	1/4, 3/8, 1/2	32	84	-	166,5	M4	32	25	50	37
15	3/8, 1/2, 3/4	41	100	-	200	M5	38,5	35	70	60
20	1/2, 3/4, 1	46	108	-	228	M5	45,5	40	80	72
25	3/4, 1, 1 1/4	55	121	-	252	M5	48	45	90	80
32	1, 1 1/4, 1 1/2	60	122	50	269	M6	49,5	45	90	80
40	1 1/2	75	131	60	304	M6	56,5	55	110	84
50	2	75	131	60	304	M6	56,5	55	110	84

## 3/2-Wege Coaxialventil 3/2-way coaxial valve



Baureihe 380 / 381  
Type 380 / 381

### Typenschlüssel type code

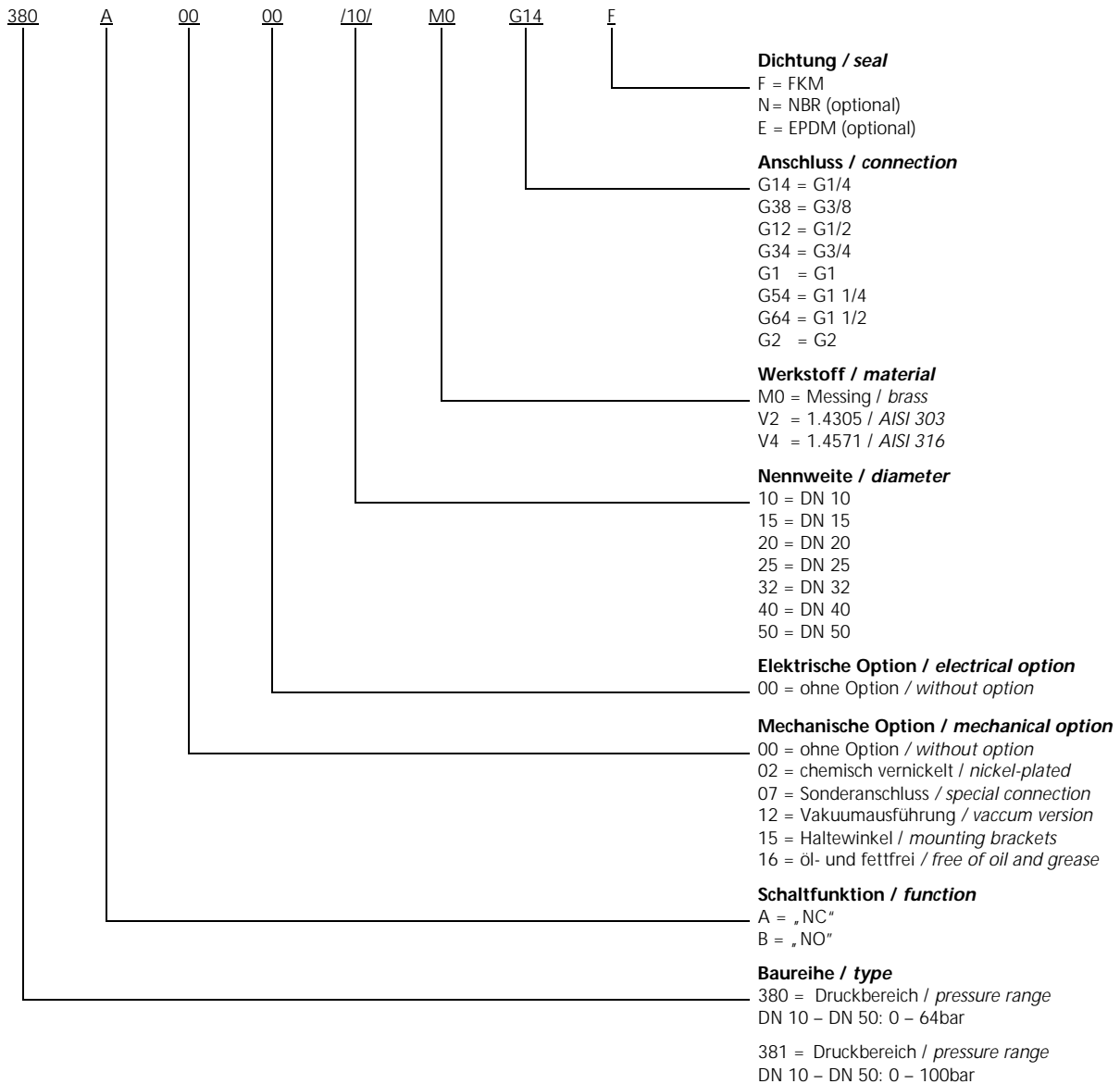

Die Typenbezeichnung setzt sich zusammen aus:  
structure of the order specification:

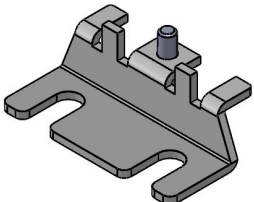
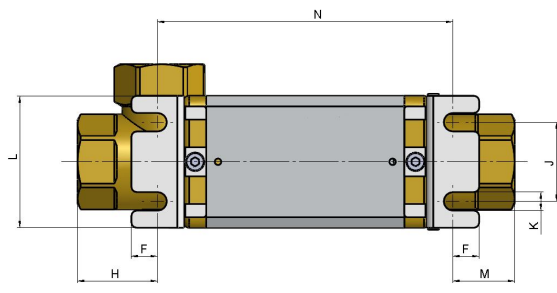

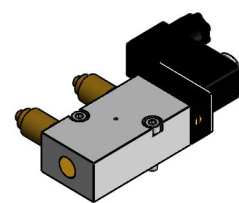
**3/2-Wege Coaxialventil**  
*3/2-way coaxial valve*
**Baureihe 380 / 381**  
**Type 380 / 381**
**Zubehör**  
*accessories*

	<p><b>Haltewinkel</b> <i>mounting brackets</i></p> <p><b>mechanische Option = 15</b> <i>mechanical option = 15</i></p>	 <table border="1" data-bbox="821 772 1428 1075"> <thead> <tr> <th>DN</th> <th>F</th> <th>H</th> <th>J</th> <th>K</th> <th>L</th> <th>M</th> <th>N</th> </tr> <tr> <th>[mm]</th> <th>[mm]</th> <th>[mm]</th> <th>[mm]</th> <th>[mm]</th> <th>[mm]</th> <th>[mm]</th> <th>[mm]</th> </tr> </thead> <tbody> <tr> <td>10</td> <td>10</td> <td>30,5</td> <td>30</td> <td>7</td> <td>50</td> <td>23,5</td> <td>113</td> </tr> <tr> <td>15</td> <td>10,5</td> <td>38,5</td> <td>45</td> <td>7</td> <td>70</td> <td>23,5</td> <td>139</td> </tr> <tr> <td>20</td> <td>15,3</td> <td>46,5</td> <td>50</td> <td>7</td> <td>80</td> <td>33,5</td> <td>149</td> </tr> <tr> <td>25</td> <td>16</td> <td>40</td> <td>60</td> <td>8,5</td> <td>90</td> <td>34</td> <td>178</td> </tr> <tr> <td>32</td> <td>6</td> <td>37</td> <td>78</td> <td>6,5</td> <td>115</td> <td>37</td> <td>195</td> </tr> <tr> <td>40</td> <td>6</td> <td>40</td> <td>98</td> <td>6,5</td> <td>130</td> <td>40</td> <td>224</td> </tr> <tr> <td>50</td> <td>6</td> <td>40</td> <td>98</td> <td>6,5</td> <td>130</td> <td>40</td> <td>224</td> </tr> </tbody> </table>	DN	F	H	J	K	L	M	N	[mm]	[mm]	[mm]	[mm]	[mm]	[mm]	[mm]	[mm]	10	10	30,5	30	7	50	23,5	113	15	10,5	38,5	45	7	70	23,5	139	20	15,3	46,5	50	7	80	33,5	149	25	16	40	60	8,5	90	34	178	32	6	37	78	6,5	115	37	195	40	6	40	98	6,5	130	40	224	50	6	40	98	6,5	130	40	224
DN	F	H	J	K	L	M	N																																																																			
[mm]	[mm]	[mm]	[mm]	[mm]	[mm]	[mm]	[mm]																																																																			
10	10	30,5	30	7	50	23,5	113																																																																			
15	10,5	38,5	45	7	70	23,5	139																																																																			
20	15,3	46,5	50	7	80	33,5	149																																																																			
25	16	40	60	8,5	90	34	178																																																																			
32	6	37	78	6,5	115	37	195																																																																			
40	6	40	98	6,5	130	40	224																																																																			
50	6	40	98	6,5	130	40	224																																																																			
	<p><b>Abluftdrossel</b> <i>exhaust air throttle</i></p> <p><b>G1/8</b> <b>G1/4</b></p>																																																																									
	<p><b>Schalldämpfer Sinterbronze</b> <i>silencer of sinter bronze casting</i></p> <p><b>G1/8</b> <b>G1/4</b></p>																																																																									
	<p><b>5/2-Wege Pilotventil (NAMUR)</b> <b>zum Anflanschen</b> <b>Anschlüsse seitlich</b> <i>5/2-way pilot valve (NAMUR) to flange connections laterally</i></p> <p><b>24V DC</b> <b>230V 50Hz</b></p>																																																																									

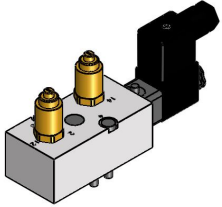
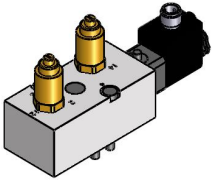
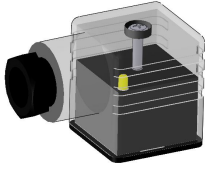
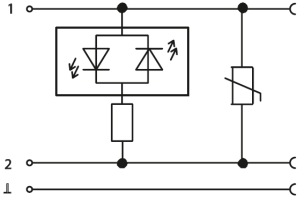
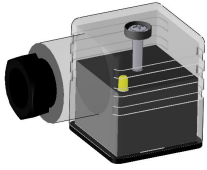
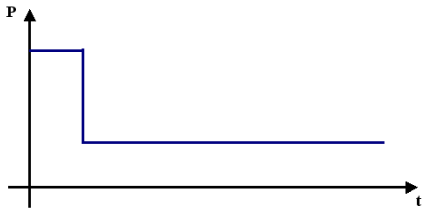
**3/2-Wege Coaxialventil**  
**3/2-way coaxial valve**
**Baureihe 380 / 381**  
**Type 380 / 381**

	<p><b>5/2-Wege Pilotventil (NAMUR) zum Anflanschen</b>  <b>Anschlüsse oben</b>  <i>5/2-way pilot valve (NAMUR) to flange connections above</i></p> <p><b>24V DC</b>  <b>230V 50Hz</b></p>	
	<p><b>5/2-Wege Pilotventil (NAMUR) zum Anflanschen</b>  <b>Anschlüsse oben</b>  <b>Magnet M12x1</b>  <i>5/2-way pilot valve (NAMUR) to flange connections above solenoid M12 x 1</i></p> <p><b>24V DC</b>  <b>230V 50Hz</b></p>	
	<p><b>Gerätesteckdose mit LED</b>  <i>plug with LED</i></p> <p><b>elektrische Option = 20</b>  <i>electrical option = 20</i></p>	
	<p><b>Gerätesteckdose mit Leistungsabsenkung</b>  <b>24V DC</b>  <b>Bauform A</b>  <i>plug with power reduction form A</i></p> <p><b>elektrische Option = 07</b>  <i>electrical option = 07</i></p>	
	<p><b>Sonderschutzart</b>  <i>explosion proof</i></p> <p><b>II 2G Ex m II T4</b>  <b>II 3D IP65 T130°C</b></p> <p><b>elektrische Option = 13</b>  <i>electrical option = 13</i></p>	<p><b>der Betriebsdruck ist bei Ex-Ausführung um ca. 20% reduziert</b>  <i>operating pressure is reduced by 20% in Ex specification</i></p>

**Weitere Optionen und Zubehör stimmen wir gerne auf Ihre Anforderungen ab.**  
*We gladly coordinate further options and accessories according to your requirements.*