

2/2-Wege Magnetventil 2/2-way solenoid valve

Baureihe 241 Type 241

**servogesteuert
schlagfrei schließend
mit einstellbarer Schließzeit**

***pilot operated
waterhammer-free
variable close muting***

Schaltfunktion A: NC (stromlos geschlossen)
function A: NC (normally closed)

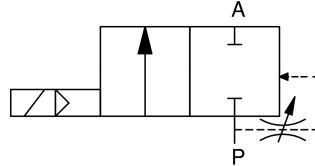

Schaltfunktion B: NO (stromlos offen)
function B: NO (normally open)

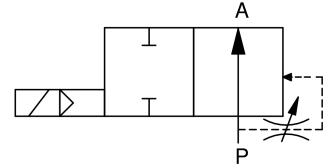

Bauart	Sitzventil mit Membrandichtung	design	seat valve with diaphragm
Nennweite	DN 32 – 50	diameter	DN 32 – 50
Druckbereich	0,5 – max. 16bar (siehe Tabelle)	pressure range	0,5 – max. 16bar (see table)
Gehäusewerkstoff	Messing, 1.4305	body material	brass, AISI 303
Dichtwerkstoff	NBR, EPDM, FKM	seal material	NBR, EPDM, FKM
Temperatur	Medium: bei NBR -20 bis +90°C bei EPDM -20 bis +130°C bei FKM -10 bis +120°C Umgebung: max. +50°C (min. Temperatur siehe Medientemperatur)	temperature	media: with NBR -20 up to +90°C with EPDM -20 up to +130°C with FKM -10 up to +120°C ambient: max. +50°C (min. temperature see media temperature)
Anschluss	G1 1/4 – G2	connection	G1 1/4 – G2
Elektr. Anschluss	Gerätesteckdose nach DIN EN 175301-803 Bauform A	electr. connection	plug acc. DIN EN 175301-803 form A
Anschlussspannung	230V 50Hz, 24V DC, Sonderspannungen	nominal voltage	230V 50Hz, 24V DC, special voltages
Spannungstoleranz	+ / - 10% nach VDE 0580	voltage tolerance	+ / - 10% acc. VDE 0580
Leistungsaufnahme	230V 50Hz: 15VA 24V DC: 18W	power consumption	230V 50Hz: 15VA 24V DC: 18W
Einschaltdauer	100% ED	duty factor	100% ED
Schutzart	IP 65 mit montierter Gerätesteckdose	protection class	IP 65 with plug mounted
Einbaulage	Magnet vorzugsweise oben	mounting	solenoid preferably in upright position

2/2-Wege Magnetventil
2/2-way solenoid valve
Baureihe 241
Type 241

DN	Druck pressure range [bar]	Anschluss connection	Kv-Wert flow rate [m ³ /h]	Gewicht weight [kg]
32	0,5 – 16	G1 1/4	15,0	3,0
40	0,5 – 16	G1 1/2	21,0	2,7
50	0,5 – 12	G2	30,0	3,7

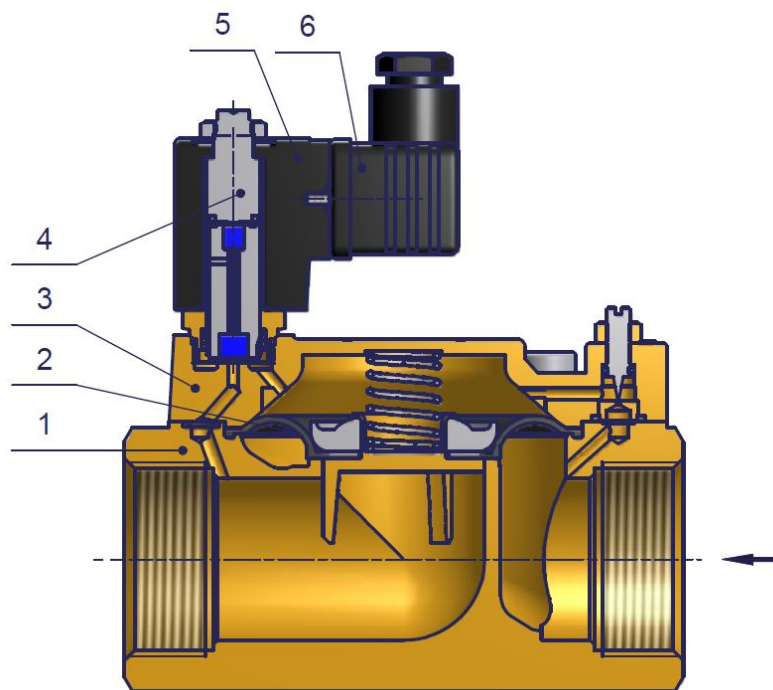
Schnittzeichnung
sectional drawing

Pos. pos.	Menge quantity	Benennung	description
1	1	Ventilkörper	valve body
2	1	Membrane	diaphragm
3	1	Deckel	top cover
4	1	Magnetschluss-hülse	solenoid tube
5	1	Magnet	solenoid
6	1	Gerätesteckdose	plug

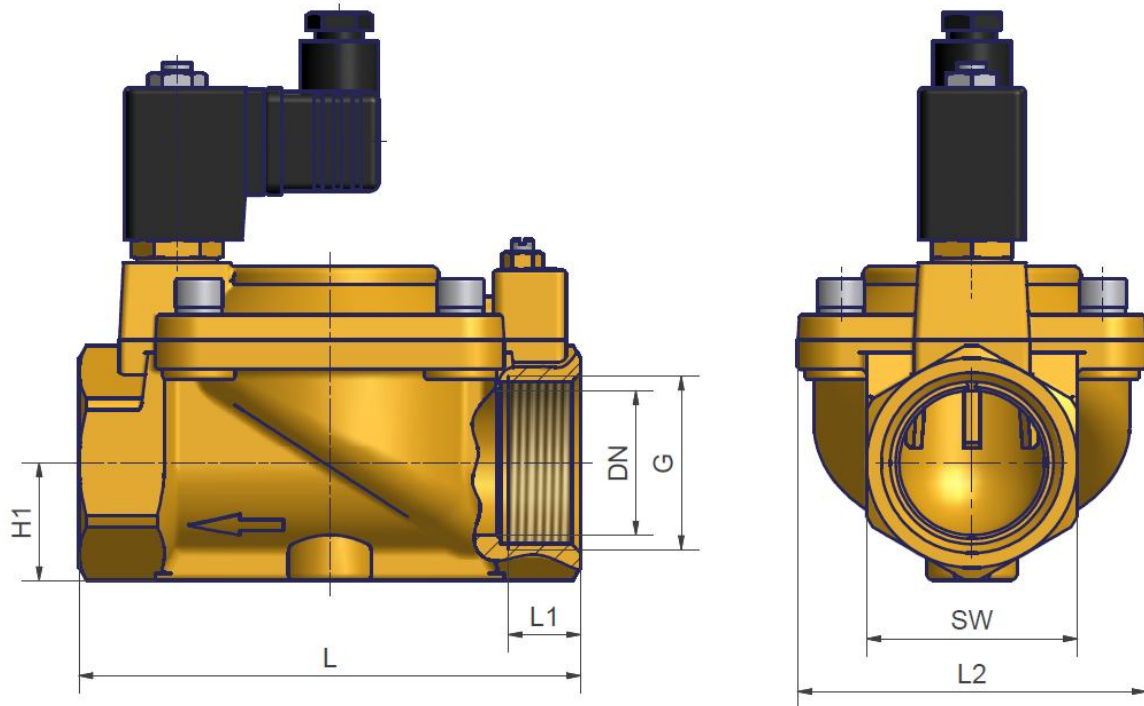
2/2-Wege Magnetventil
2/2-way solenoid valve
Baureihe 241
Type 241
Maßzeichnung
dimension drawing

DN	G	SW [mm]	H1 [mm]	L [mm]	L1 [mm]	L2 [mm]
32	1 1/4	58	33	140	22	96
40	1 1/2	58	33	140	22	96
50	2	70	40	168	25	112

2/2-Wege Magnetventil 2/2-way solenoid valve



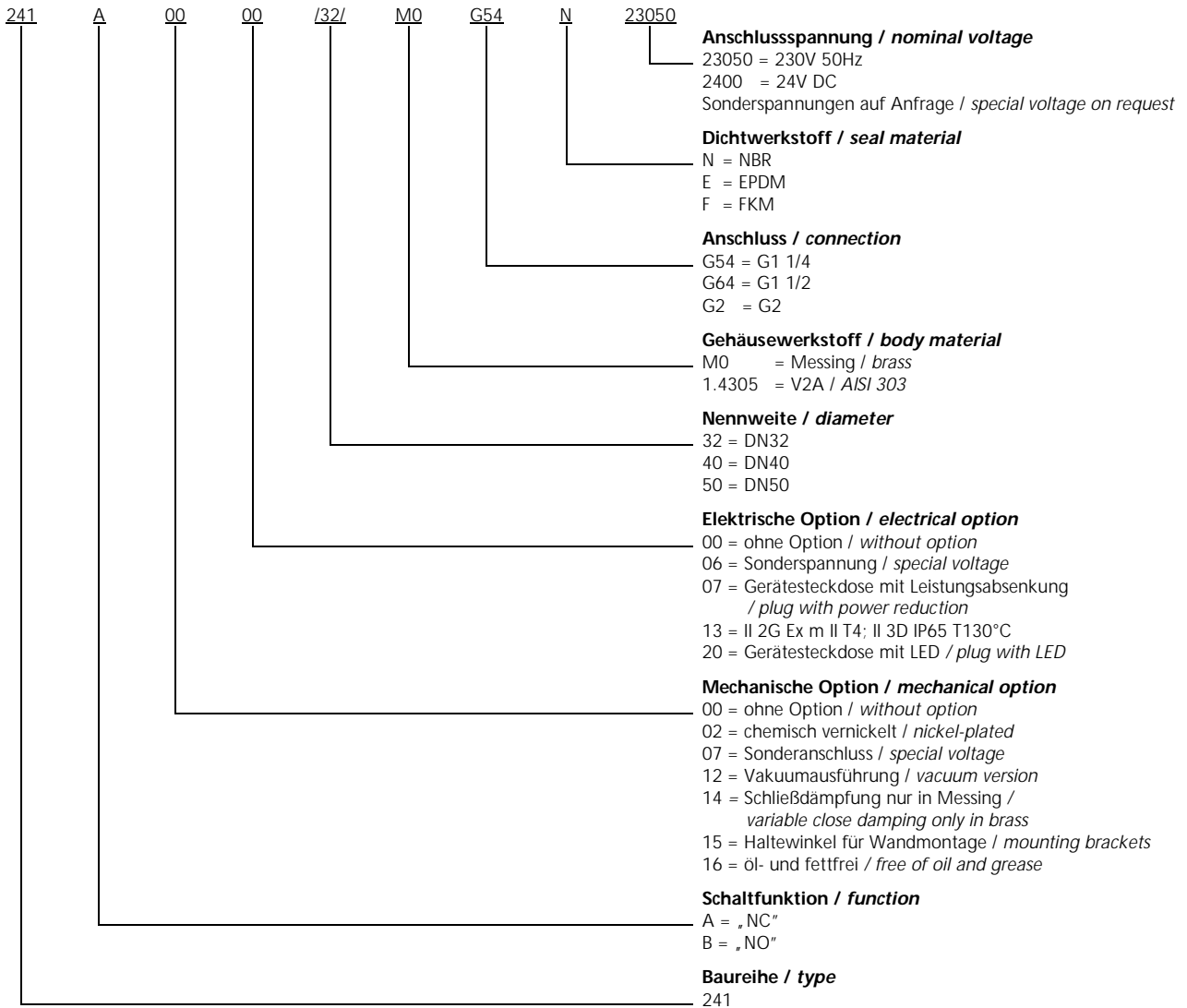

Baureihe 241 Type 241

Typenschlüssel type code



Die Typenbezeichnung setzt sich zusammen aus:
structure of the order specification:

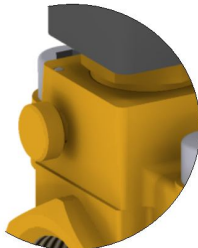
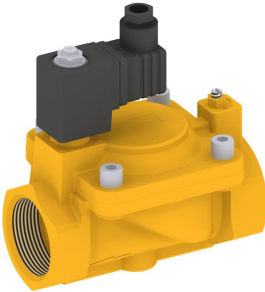

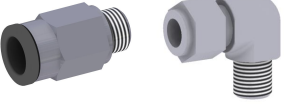
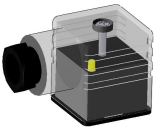
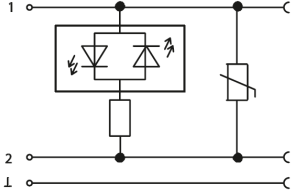
2/2-Wege Magnetventil
2/2-way solenoid valve
Baureihe 241
Type 241
Zubehör
accessories

	<p>Haltewinkel <i>mounting brackets</i></p> <p>mechanische Option = 15 <i>mechanical option = 15</i></p>	
	<p>Handnotbetätigung <i>manual override</i></p> <p>mechanische Option = 08 <i>mechanical option = 08</i></p>	
	<p>Schließdämpfung nur in Messing <i>variable close damping only in brass</i></p> <p>mechanische Option = 14 <i>mechanical option = 14</i></p>	
	<p>Verschraubungen <i>fittings</i></p>	<p>siehe Datenblatt Verschraubungen <i>see datasheet fittings</i></p>
	<p>Gerätesteckdose mit LED <i>plug with LED</i></p> <p>elektrische Option = 20 <i>electrical option = 20</i></p>	

2/2-Wege Magnetventil
2/2-way solenoid valve
Baureihe 241
Type 241

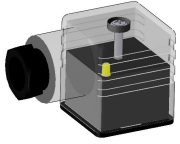
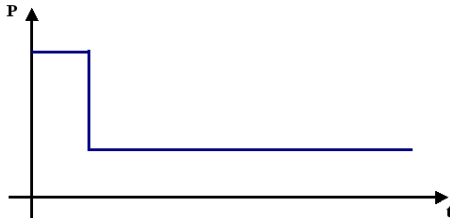
	<p>Sonderschutzart <i>explosion proof</i></p> <p>II 2G Ex m II T4 II 3D IP65 T130°C</p> <p>elektrische Option = 13 <i>electrical option = 13</i></p>	<p>der Betriebsdruck ist bei Ex-Ausführung um ca. 20% reduziert <i>operating pressure is reduced by 20% in Ex specification</i></p>
	<p>Gerätesteckdose mit angespritztem Kabel <i>plug with cable</i></p>	
	<p>Gerätesteckdose mit Leistungsabsenkung 24V DC Bauform A <i>plug with power reduction 24V DC, form A</i></p> <p>elektrische Option = 07 <i>electrical option = 07</i></p>	

Weitere Optionen und Zubehör stimmen wir gerne auf Ihre Anforderungen ab.
We gladly coordinate further options and accessories according to your requirements.